

Active Transmitter Combiner 8:1 AC 3000

Bedienungsanleitung
Instructions for use
Notice d'emploi
Istruzioni per l'uso
Instrucciones para el uso
Gebruiksaanwijzing

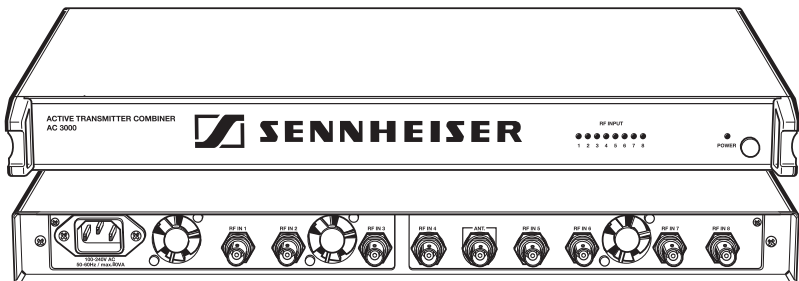

Bedienungsanleitung.....	3
Instructions for use	13
Notice d'emploi	23
Istruzioni per l'uso.....	33
Instrucciones para el uso.....	43
Gebruiksaanwijzing.....	53

Active Transmitter Combiner 8:1 **AC 3000**

Instructions for use

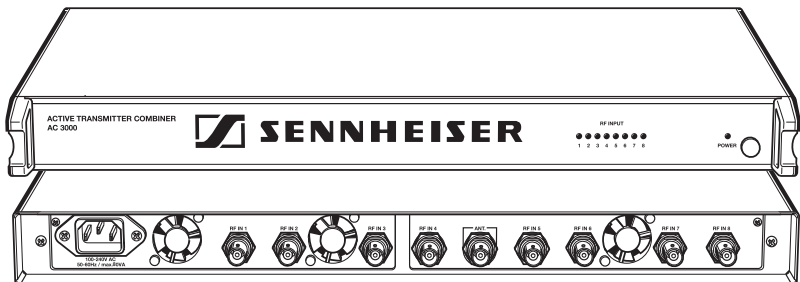

Contents

AC 3000	13
Active Transmitter Combiner 8:1	13
Contents	14
Brief description	14
Safety instructions	15
Delivery includes	17
Operating elements	17
Connection diagram	18
Putting the unit into operation	18
Operation	20
Troubleshooting	20
Accessories	21
Specifications	21
Garantee	22

Brief description

With the AC 3000 8-to-1 active transmitter combiner, the signals of up to eight SR 3054 transmitters or up to four SR 3056 twin transmitters can be combined onto a single antenna (A 2003 UHF directional antenna or A 1031 U omni-directional antenna).

The active transmitter combiner allows you to make high-quality transmission systems with up to 8 channels.

Areas of application:

- Multi-channel in ear monitoring system for broadcast or stage use
- Multi-channel system suitable for any application where talk-back signals are to be transmitted (e.g. studio)

Safety instructions

Danger!



Overheating or overvoltages (caused by lightning striking the mains supply etc.) can cause units with a mains connection to catch fire!

Always set up the unit in a well-ventilated place! Make sure that the air vents of the unit are not covered or blocked! Never stack more than two units directly one above the other! Do not set up the unit near any heat sources and never expose the unit to direct sunlight (see page 15)! Use an overvoltage protection or, during a thunderstorm, disconnect the unit from the mains!

The AC 3000 contains mechanically moving parts (fans). Since dust and pollution can impair their function, you should regularly check the fans for proper operation and clean out any dust if necessary. The failure of one or several fans can cause overheating and permanent damage to the unit.

Warning!



If you open units or use damaged mains cables, you can receive a dangerous electric shock!

Never open the unit and only use undamaged mains cables! If a unit should be defective, repair must be carried out by authorized personnel! If units are opened by you in breach of this instruction, the warranty becomes null and void.

Warning!



If units and cables are set up improperly, persons can be injured or units can be damaged!

Set up the unit on an even surface or mount it into a rack! Lay the cables in such a way that no-one can stumble over them!

Attention!



If liquids or small parts which conduct electricity find their way into the interior or to the sockets of the unit, this can cause a short-circuit which may damage the unit!

Keep liquids and small parts which conduct electricity away from the unit! Use a damp cloth for cleaning the unit. Do not use any solvents or cleansing agents!

Delivery includes

- 1 active transmitter combiner 8:1
- 1 mains cable
- 1 rack-mounting kit
- 4 set of self-adhesive plastic feet
- 1 instruction manual

You additionally require BNC cables for connecting the transmitters and the antenna to the AC 3000, an antenna (A 2003 UHF passive directional antenna or A 1031 U passive omni-directional antenna) and up to eight SR 3054 transmitters or up to four SR 3056 twin transmitters.

Operating elements

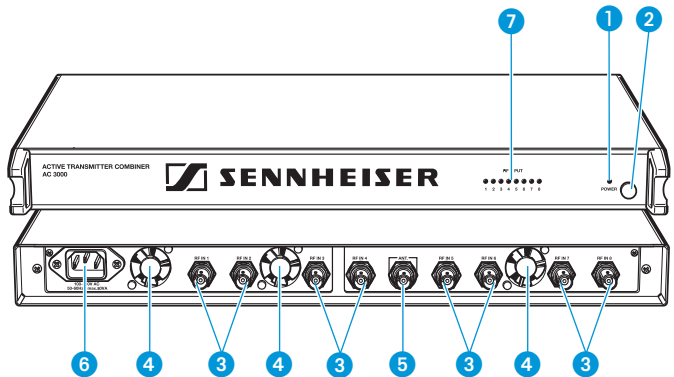

- 1 POWER LED
- 2 POWER (ON/OFF) switch
- 3 8 RF inputs RF IN 1 to RF IN 8 for connecting the transmitters
- 4 3 low-noise fans
- 5 BNC socket for antenna output ANT
- 6 IEC mains socket
- 7 8 LEDs for RF signal indication

Connection diagram

The below connection diagram shows the connections for an 8-channel system.

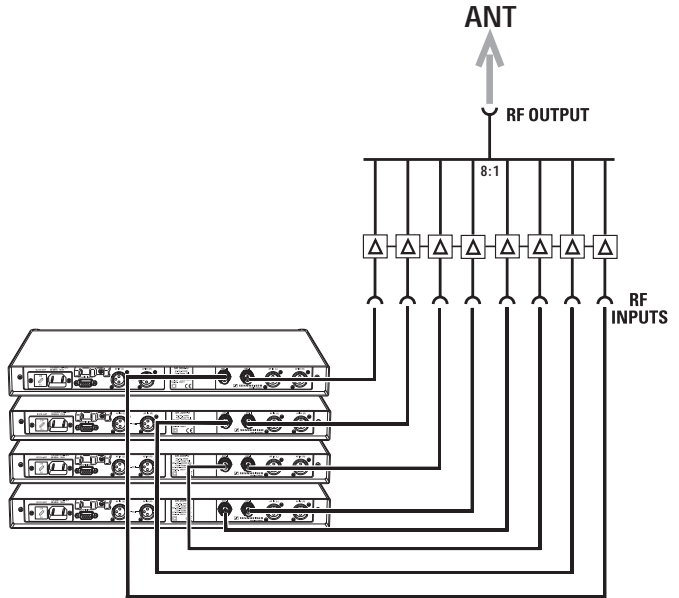

Putting the unit into operation

Setting up the unit

- ▶ Set up the AC 3000 on an even, horizontal surface so that it cannot fall over or mount it into a 19" rack.

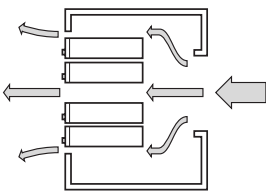

Warning!

During operation, the AC 3000 and the connected transmitters produce considerable waste heat! Make sure that the air vents of the units are not covered or blocked and provide for a duct of sufficient size to ensure a free air flow between the units – especially when mounting several transmitter combiners or transmitters into a desk, chassis or rack! Never stack more than two units directly one above the other!

Connecting the antenna

The AC 3000 active transmitter combiner can be used with either the A 2003 UHF directional antenna or the A 1031 U omni-directional antenna. The antenna transmits the signals of all connected transmitters. The signals are combined onto the antenna output with no distribution attenuation.

- ▶ Connect the antenna to the antenna output **ANT** **5**.

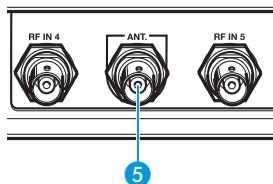

Note:

Each AC 3000 requires its own antenna! Several AC 3000s **cannot** be daisy-chained!

Connecting the transmitters

You can connect up to eight SR 3054 transmitters or up to four SR 3056 twin transmitters to the AC 3000.

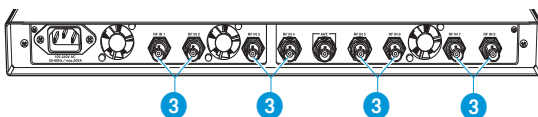

- ▶ Use BNC cables to connect the transmitters to the RF inputs **RF IN 1** to **RF IN 8** **3**.

Connecting the mains cable

- ▶ Connect the mains cable to the IEC mains socket **6** and to the mains.

Note:

The AC 3000 can be connected to any mains power supply with 100 V to 240 V AC (50 to 60 Hz).

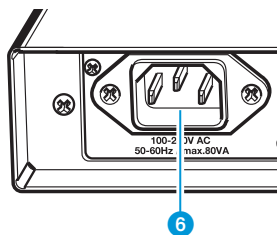

Operation

Turning the AC 3000 on and off

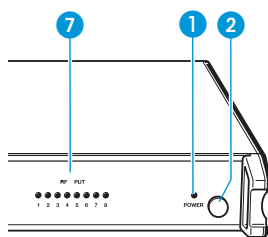

- ▶ To turn the AC 3000 on, press the **POWER (ON/OFF)** switch **2**.
The **POWER LED 1** lights up red.
- ▶ To turn the AC 3000 off, press the **POWER (ON/OFF)** switch **2** once more. The **POWER LED 1** goes off.

RF signal indication

- ▶ The AC 3000 features eight control LEDs **7** which will light up if an input signal is present at the corresponding input.

Troubleshooting

One or several LEDs for input signal indication **7** do not light up

- ▶ Check if transmitters are connected to the corresponding inputs.
- ▶ Check if the corresponding transmitters are turned on.

Disturbed reception or no reception

Possible causes:

- Transmitting antennas are not within the reception area
- Transmitters or receivers are not turned on
- Batteries are not inserted into the receiver or batteries are low
- The antennas are not connected correctly
- The connecting cables are defective
- Too high cable attenuation due to too long antenna cables or wrong type of antenna cable
- The selected transmission and receiving frequencies are not within the frequency window

Accessories

The following accessories are available from Sennheiser:

- A 2003 UHF** Passive directional antenna Cat. No. 03658
- A 1031 U** Passive omni-directional antenna
Cat. No. 04645
- GZL 1019 A1** BNC-BNC coaxial cable, length 1 m
Cat. No. 02324
- GZL 1019 A5** BNC-BNC coaxial cable, length 5 m
Cat. No. 02325
- GZL 1019 A10** BNC-BNC coaxial cable, length 10 m
Cat. No. 023266

Specifications

Antenna combiner	8-to-1
Frequency range	470 – 870 MHz
Distribution attenuation	0 dB (± 1 dB)
RF input power	max. 100 mW per input
Impedance	50 Ω
Power supply	100 V – 240 V AC, 50 – 60 Hz
Current consumption	max. 120 VA
Temperature range	-10 °C to +55°C
Weight	3 kg

Garantee

The guarantee period for this Sennheiser product is 24 months from the date of purchase. Excluded are accessory items, rechargeable or disposable batteries that are delivered with the product; due to their characteristics these products have a shorter service life that is principally dependent on the individual frequency of use.

The guarantee period starts from the date of original purchase. For this reason, we recommend that the sales receipt be retained as proof of purchase. Without this proof (which is checked by the responsible Sennheiser service partner) you will not be reimbursed for any repairs that are carried out.

Depending on our choice, guarantee service comprises, free of charge, the removal of material and manufacturing defects through repair or replacement of either individual parts or the entire device. Inappropriate usage (e.g. operating faults, mechanical damages, incorrect operating voltage), wear and tear, force majeure and defects which were known at the time of purchase are excluded from guarantee claims. The guarantee is void if the product is manipulated by non-authorized persons or repair stations.

In the case of a claim under the terms of this guarantee, send the device, including accessories and sales receipt, to the responsible service partner. To minimise the risk of transport damage, we recommend that the original packaging is used. Your legal rights against the seller, resulting from the contract of sale, are not affected by this guarantee.

The guarantee can be claimed in all countries outside the U.S. provided that no national law limits our terms of guarantee.



Sennheiser electronic GmbH & Co. KG
30900 Wedemark, Germany
Phone +49 (5130) 600 0
Fax +49 (5130) 600 300
www.sennheiser.com